



anemoi
live wind indication

RS FLIGHT
SYSTEMS

Installation / Operation Manual



Contents

1.	Preface.....	3
1.1	Limited Warranty	3
1.2	Sunburned Display Warranty	3
1.3	Overview Software Versions	4
2.	System Description	5
3.	Technical Specifications	7
3.1	Available Accessories	8
4.	Mechanical Installation	9
4.1	Display Unit.....	9
4.2	Display Unit E1.....	9
4.3	Sensor Unit	10
4.4	Temperature sensor installation	11
4.5	Pressure Connectors	12
4.6	Drawings Display Unit	13
4.7	Drawings Display Unit E1	14
4.8	Drawings Sensor Unit.....	14
5.	Electrical Installation	16
5.1	Display 1 / Display 2 Connector	17
5.2	GPS NMEA Connector	17
5.3	POWER Connector	19
5.4	GPS Receiver Connector	20
5.5	Wiring Diagram.....	21
6.	Operation	22
6.1	Startup	22
6.2	Display pages	22
	Wind Page	23
	AHRS page	23
	Data page	23
6.3	Operation on ground	23
6.4	In-Flight operation	24
	Use of data indicated by anemol.....	24
	Data interpretation and reliability.....	24
6.5	Setup Menu	25
	Calibrate PRS	26
	Rotate Screen	26
	Disable AHRS	26
	Align DOF.....	27
	Exit.....	28
6.6	Errors	28
	Sensor error.....	28
	-no data-.....	28
6.7	Firmware / Software Update	29
7.	Abbreviations and Terms	30

1. Preface

Thank you for purchasing an RS Flight Systems **anemoi**. We are pleased that you have chosen our product and are confident that it will meet all your expectations. In case of questions or problems with the unit, feel free to contact:

Service and Support:

Ülis Segelflugbedarf GmbH
Untergasse 1
63688 Gedern | Germany
+49 6045 950100
info@segelflugbedarf24.de

Development and Production:

RS Flight Systems GmbH
Oberer Luessbach 29-31
82335 Berg | Germany
anemoi@rs-flight-systems.com

The **anemoi** system is designed exclusively for VFR use as an aid to navigation. All information is presented for reference only. Wind, AHRS and air data are provided as an aid to situation awareness. Information in this document is subject to change without notice. RS Flight Systems reserve the right to change or improve their products and to make changes in the content of this material without obligation to notify any person or organization of such changes or improvements.

1.1 Limited Warranty

This RS Flight Systems product is warranted to be free from defects in materials or workmanship for two years from the date of purchase. Within this period, RS Flight Systems will, at their sole discretion, repair or replace any components that fail in normal use. Such repairs or replacement will be made at no charge to the customer for parts and labor, provided that the customer shall be responsible for any transportation cost. This warranty does not cover failure due to abuse, misuse, accident, or unauthorized alterations or repairs. RS Flight Systems displays damaged by direct or magnified sunlight are not covered under warranty. To obtain warranty service, contact Ülis Segelflugbedarf or RS Flight Systems directly.

1.2 Sunburned Display Warranty

The **anemoi** display screen can be damaged or burned by strong sunlight magnified by canopies in certain positions. We suggest covering your device from direct sunlight, especially if the canopy is open. **anemoi** displays damaged by direct or magnified sunlight are not covered under warranty.

1.3 Overview Software Versions

Version	Change Overview	Release date
1.0	<ul style="list-style-type: none">Initial Version	09.03.2022
1.1	<ul style="list-style-type: none">Enhanced AHRS lock	30.03.2022
1.2	<ul style="list-style-type: none">Enhanced GPS NMEA inputKalman Filter improvement for long, straight flights	16.04.2022
1.3	<ul style="list-style-type: none">Improved robustness of NMEA parserCorrected formula for FL calculationImproved average wind calculation	06.07.2022

Table 1-1: Software Versions Sensor Unit

Version	Change Overview	Release date
1.0	<ul style="list-style-type: none">Initial Version	30.03.2022

Table 1-2: Software Versions Display Unit (metric)

Version	Change Overview	Release date
2.0	<ul style="list-style-type: none">Initial Version imperial units	06.07.2022

Table 1-3: Software Versions Display Unit (imperial)

2. System Description

The **anemoi** comprises one sensor and one display unit. Its functionality is as follows:

- Precise indication of wind vector, artificial horizon (AHRS) and flight data (TAS, GS, OAT, FL)
- Stand-alone system architecture
- Sunlight-readable backlit display
- Simple and self-explanatory operation (one push button)
- Minimum installation effort of sensor unit – uninfluenced by magnetic fields
- Compact display unit with versatile installation options
- Simple data transfer and software update via microSD card
- Suitable for 12 VDC aircraft electrical systems
- High level of manufacturing and quality control
- Engineering and production exclusively done in Germany



Figure 2-1: Sensor Unit



Figure 2-2: Display Unit



Figure 2-3: Wiring Harness Kit



Figure 2-4: Connection Kit

3. Technical Specifications

	Sensor Unit	Display Unit
Dimensions (width, height, depth)	130 x 55 x 35 mm 5.12 x 2.17 x 1.38 in	44 x 30 x 10 mm 1.73 x 1.18 x 0.39 in
Mounting Depth incl. connectors	70 mm 2.76 in	25 mm 1.00 in
Mounting	4x M4 screws 120 x 40 mm 4.72 x 1.57 in	Taped Connector Cutout: 14 x 16 mm 0.55 x 0.63 in Display Cutout: 26 x 26 mm 1.02 x 1.02 in
Total Mass	180 g 0.4 lbs	20 g 0.04 lbs
Housing	Machined aluminum, surface black anodized	Polyamide 12
Supply Voltage	12 VDC	
Power Consumption	100 mA	
Display	1.3-inch LCD, 240 x 240 pixels	
Firmware Update	microSD card, up to 32 GB, FAT32 formatted	
Operating Temperature Range	-20 to +60 °C -4 to +140 °F	
Operating Altitude	< 7,620 m < 25,000 ft	
Humidity	< 95 %, non-condensing	

Table 3-1: Technical Specification

3.1 Available Accessories

Part No.	Name	Description
10-757	anemoi Wind Indication System	Live wind indication system for aircraft Kit consists of Sensor Unit and Display Unit Power supply: 12 VDC Sensor Unit: 130 x 55 x 35 mm Display Unit: 44 x 30 x 10 mm Includes wiring harness 10-752 and connection kit 10-756
26005-455	anemoi Display Unit	Display Unit for anemoi live wind indication system 240 x 240 pixels TFT screen, ultra-bright Dimensions: 40 x 30 x 10 mm
26005-453	anemoi Display Unit E1	Display Unit for anemoi live wind indication system Installation variant for mounting in the instrument panel 240 x 240 pixels TFT screen, ultra-bright Dimensions: 53 x 40 x 11 mm
26005-485	anemoi Sensor Unit	Sensor Unit for anemoi live wind indication Power supply: 12 VDC Dimensions: 130 x 55 x 35 mm
10-752	Wiring Harness Kit anemoi	Power wires, length 0.5 m (1.5 ft) Temperature Sensor, length 1.0 m (3 ft)
10-781	Wiring Harness Kit anemoi (3m)	Power wires, length 3.0 m (10 ft) Temperature Sensor, length 3.0 m (10 ft)
10-756	Connection Kit anemoi	Connection Kit for anemoi wind indicator system. Includes: - Display cable RJ12 0.5 m (1.5 ft) - NMEA cable RJ45 0.5 m (1.5 ft) - NMEA RJ45 Y-splitter (1:1) - 2x T-Reduction Nozzles instrument hose - Silicone hose 3 x 5 mm (0.12"), length 1.0 m (3 ft)
10-782	Connection Kit anemoi (3m)	Connection Kit for anemoi wind indicator system. Includes: - Display cable RJ12 3.0 m (10 ft) - NMEA cable RJ45 3.0 m (10 ft) - NMEA RJ45 Y-splitter (1:1) - 2x T-reduction nozzles instrument hose - Silicone hose 3 x 5 mm (0.12"), length 6.0 m (20 ft)
10-744	Cable RJ12 0,5m	anemoi Display Unit cable Length: 0.5 m (1.5 ft)
10-778	Cable RJ12 3,0m	anemoi Display Unit cable Length: 3.0 m (10 ft)
10-745	Cable RJ45 0,5m	NMEA cable anemoi Length: 0.5 m (1.5 ft)
10-779	Cable RJ45 3,0m	NMEA cable anemoi Length: 3.0 m (10 ft)
10-746	Y-Adapter RJ45	Y-Adapter for RJ45 cable 1:1 Splitter, shielded
10-747	T-Reduction Nozzle 6-4-6 mm	T-reduction nozzle 6mm-4mm-6mm (0.24"-0.16"-0.24") Connection of anemoi static pressure and total pressure hose
10-759	Silicone Hose 3x5 mm	Silicone hose, transparent Inner diameter: 3 mm (0.12")
10-875	Klixon Circuit Breaker 7277-2-1	Small size and lightweight circuit breaker Rating: 1 A
10-887	Mounting Adapter anemoi 57mm	anemoi adapter for 57 mm (2.25") instrument panel cutout
13100-177	GPS GNSS Receiver	High precision GPS GNSS receiver Accepts the signals of up to 50 satellites at the same time Sensibility max. -162 dBm, IPX6 protection class Cable length: 1.5 m (5 ft) Dimensions: 65 x 45 x 22 mm

Table 3-2: Accessories

4. Mechanical Installation

Upon delivery, undertake visual inspection of the package contents for signs of transport damage and verify the information on the type plate sticker against your order. Do not open the device housing.

For longer storage of the device, select a dry and clean environment. Make sure that the device is not stored near strong heat sources and that no metal chippings or other dirt can get into the device or its connectors.

4.1 Display Unit

The display unit is mounted either in front of the instrument panel or behind the instrument panel. Second variant needs a rectangular cutout (dimensions in Table 3-1). Two mounting examples are shown in Figure 4-1 and Figure 4-2.

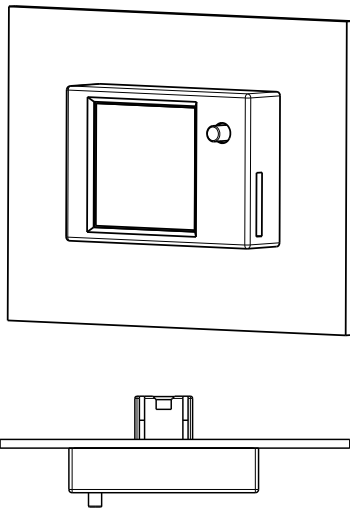

Figure 4-1: Front side mounting

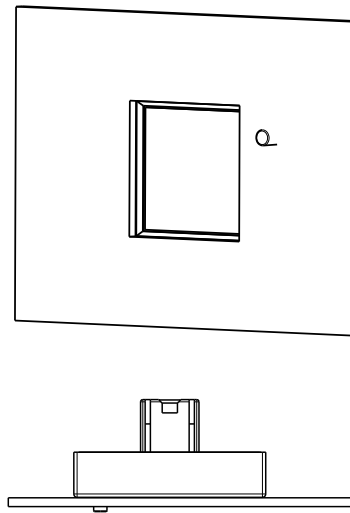

Figure 4-2: Rear side mounting

4.2 Display Unit E1

The Display Unit E1 must be installed with four M2.5 screws in the instrument panel.

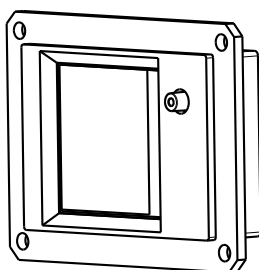

Figure 4-3: Isometric view E1 display

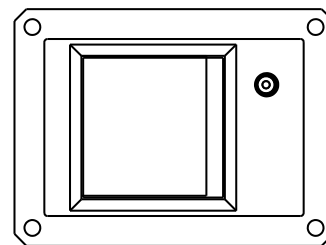

Figure 4-4: Front view E1 display

4.3 Sensor Unit

The sensor unit can be mounted behind the instrument panel or in the fuselage. By default, the **anemoi** is delivered with a 0.5 m (3.0 ft) wiring harness kit. As an accessory, a 3.0 m (10 ft) wiring harness kit is available. The sensor unit is mounted with 4x M4 screws. The screw hole positions can be taken from Figure 4-14.

The mounting position of the sensor unit is shown in Figure 4-5.

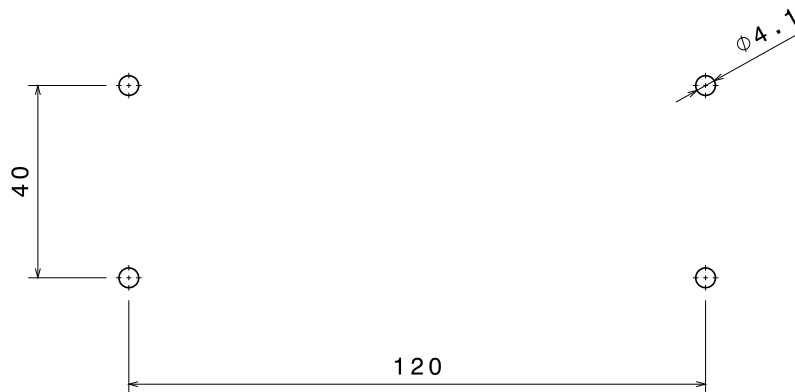

Figure 4-5: Mounting cutout sensor unit

The sensor unit needs to be aligned with the aircraft axes by the following margins:

- Yaw axis: $\pm 1^\circ$. Misalignment leads to inaccurate wind indication during longer straight flight segments without moderate changes in airspeed and heading.
- Roll axis: $\pm 3^\circ$. Misalignment leads to permanent offset of the roll angle indicated by the artificial horizon (AHRS), and potentially falsifies wind indication during longer straight flight segments.
- Pitch axis: $\pm 7^\circ$. Alignment can be adjusted and chosen within a relatively wide-angle range with no noticeable effect on wind indication. The mounting pitch attitude of the sensor unit will be indicated as “zero pitch” on the artificial horizon (AHRS).

The sensor unit must always be mounted so that the labeled side of the device is “up”. A vertical mounting is not possible.

The alignment of $\pm 1^\circ$ in the yaw axis can be done with the help of a try square on the rear side of the instrument panel or with a string from the fin to the nose of the sailplane.

The sensor unit can be mounted in four different yaw orientations, indicated as A, B, C, D on the top side of the sensor unit. If the sensor unit is installed with direction A pointing in the DOF (direction of flight) no further action is required upon installation. If the sensor unit is installed in the directions of

B/C/D, the DOF must be set in the menu once after installation, as explained in chapter 6.3: Setup Menu under “Align DOF”.

Three-dimensional CAD-models of the units and the cutout of the display unit are available at the RS Flight Systems website.

As waste heat is dissipated via free convection, leave at least a 5 mm gap from the aluminum surfaces to any other object. Forced cooling is not necessary.

The installation must be in accordance with the appropriate guidelines approved by the respective aviation authority. The person installing the device is responsible for compliance with all applicable legislation.

Two examples of the installation are shown in the following figures:



Figure 4-6: Installation ASW 22 BL



Figure 4-7: Installation HK 36 TTC

4.4 Temperature sensor installation

It is recommended to install the temperature probe as closely to outside air temperature (OAT) as practically possible, e. g. inside the nose tip or in the front air vent of the aircraft.

Errors in temperature measurement (usually, too warm measurement due to heating from cockpit systems) can have an impact on the airspeed calibration and therefore negatively influence wind calculation. However, the system’s sensitivity to temperature errors is quite low, and the **anemoi** software is even capable of adjusting to permanent temperature measurement offsets within the first ~15 minutes after takeoff. Nevertheless, good temperature measurement is necessary for ideal performance of the wind indication.

4.5 Pressure Connectors

P_{TOTAL} must be connected with the total pressure tube, P_{STATIC} with the static pressure tube. Do not use the P_{STATIC} from a Multi Probe. Instead, the same P_{STATIC} as used for the airspeed indicator must be used. The pressure connectors and pressure tubes need to be properly sealed as leakage leads to errors in the external airspeed indicator and altimeter. During pre-flight check both instruments need to be checked for their proper functionality.

4.6 Drawings Display Unit

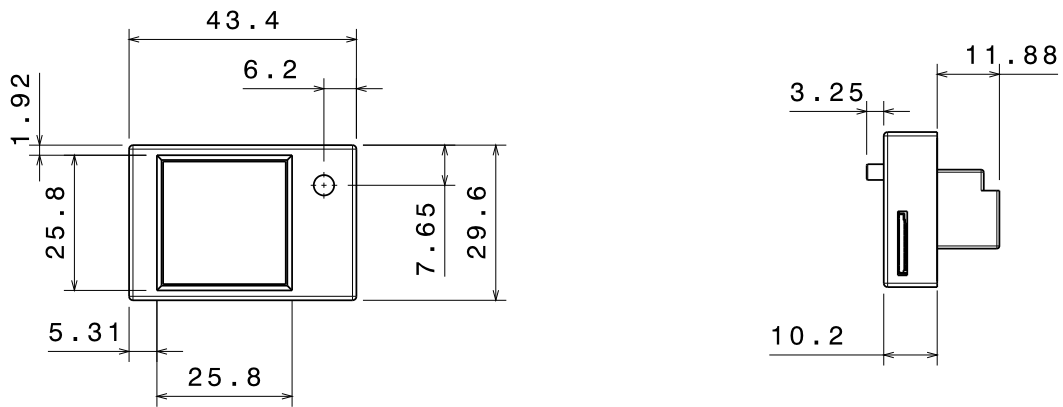

Figure 4-8: Display unit (front view / side view)

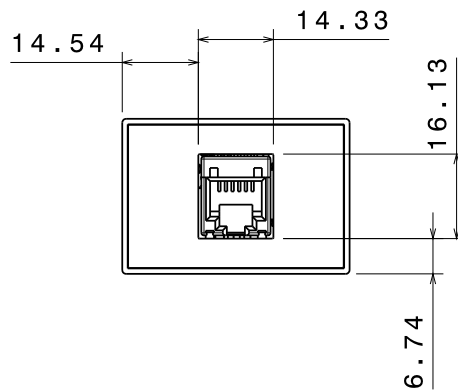

Figure 4-9: Display unit (rear view)

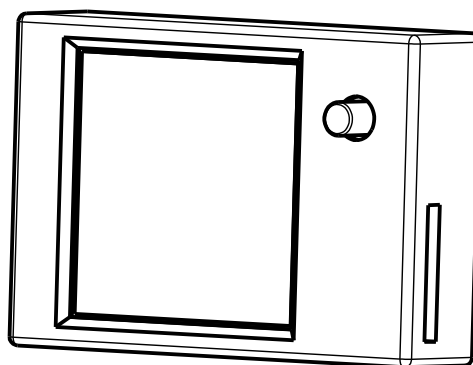

Figure 4-10: Display unit (isometric view)

4.7 Drawings Display Unit E1

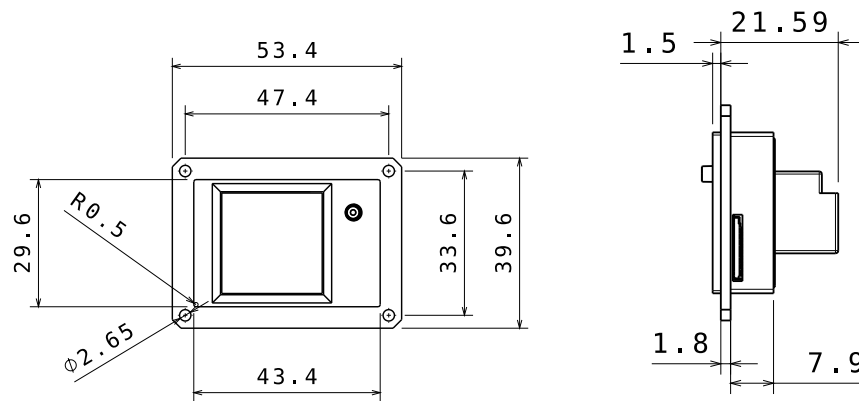

Figure 4-11: Display unit E1 (front view / side view)

4.8 Drawings Sensor Unit

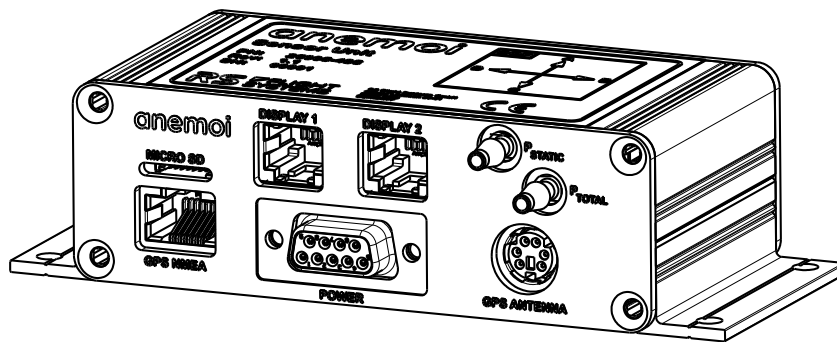

Figure 4-12: Sensor unit (isometric view)

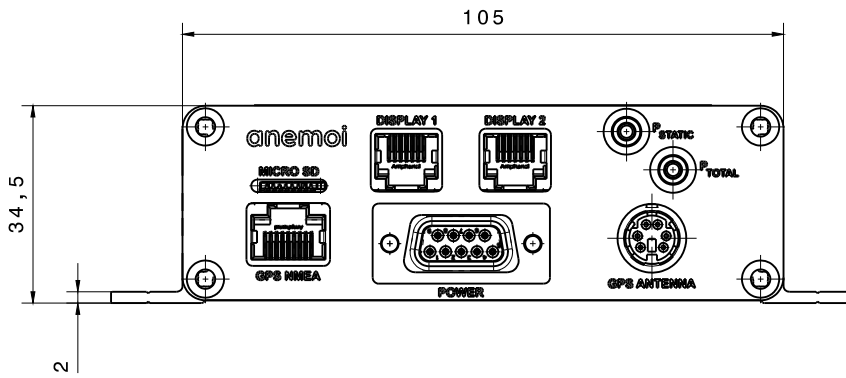

Figure 4-13: Sensor unit (front view)

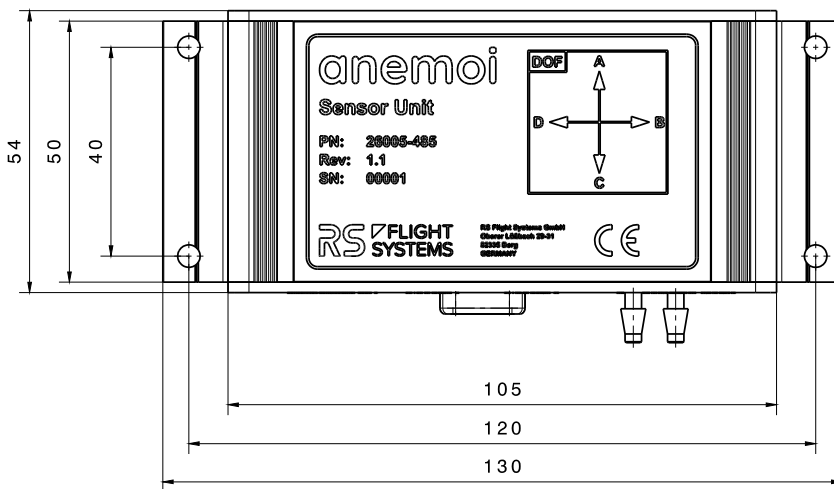

Figure 4-14: Sensor unit (top view)

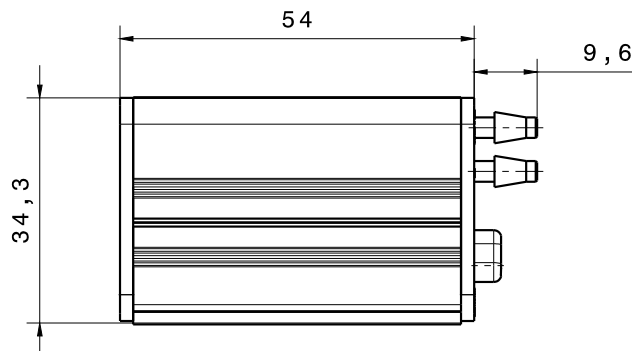

Figure 4-15: Sensor unit (side view)

5. Electrical Installation

The sensor unit has six electrical connectors and two pressure connectors on the front side. The front side of the sensor unit is shown in Figure 5-1. Label, type of connector and usage are listed in Table 5-1. Before powering up the unit for the first time, carefully check your wiring.

There is one microSD slot to update the firmware, one RJ45 connector to import GPS data from the NMEA output. There is also an optional DIN-style connector for an external GPS receiver to import GPS data. The P/N of the mating GPS receiver is listed in Table 3-2. Two RJ12 connectors transmit data to the external displays. The D-Sub Power connector is the main connector to power up **anemoi**. As shown in the pinout, see Table 5-1 below, D-Sub has power input and an external temperature sensor wired to it.

GPS data can be provided by a GPS receiver or a device with NMEA output. Make sure that only one is connected to the sensor unit. Never plug in both, NMEA output and GPS receiver, simultaneously.

If there is an NMEA output device: make sure to use the RJ45 splitter to split up the power supply and the data lines. The RJ45 data cable is connected directly to the sensor unit in the GPS NMEA slot. The RJ45 power cable is connected to the default NMEA output power source.

If there is no NMEA output device: plug in the GPS cable in the GPS receiver slot. Place the GPS receiver in a spot where it has maximum optical visibility of the sky, e. g. the glare shield on top of the instrument panel. Poor GPS reception has a negative impact on the operation of the unit. It impairs the accuracy of the wind vector and of the ground speed data.

Label	Connector Type	Usage
"DISPLAY 1"	RJ12 (female 6-pin)	External Display
"DISPLAY 2"	RJ12 (female 6-pin)	External Display
"P STATIC"	Tube	Static Pressure
"P TOTAL"	Tube	Total Pressure
"POWER"	DB9S (female 9-pin D-Sub)	Power Supply and Temperature Sensor
"GPS RECEIVER"	Female Mini-DIN 6	GPS
"GPS NMEA"	RJ45 (female 8-pin)	GPS
"MICRO SD"	MICRO SD	Firmware Upgrade

Table 5-1: Connector overview

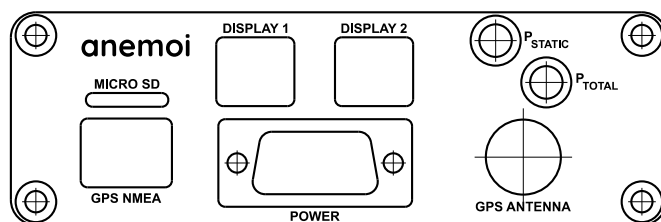

Figure 5-1: Sensor Unit Front View

5.1 Display 1 / Display 2 Connector

Displays 1 and 2 use a standard RJ12 connector (6P/6C). Pins 1 and 2 are supplied with +5 VDC, Pins 5 and 6 are ground. The extended pin allocation is shown in Table 5-2. The pin numbering is shown in Figure 5-2.

Pin Number	Signal Name	Function
1	PWR_OUT	Display Unit Power Supply, +5 VDC
2	PWR_OUT	Display Unit Power Supply, +5 VDC
3	BUTTON	Display Unit Button line
4	DATA	Display Unit Data line
5	DISPLAY_GND	Display Unit Power Supply Ground
6	DISPLAY_GND	Display Unit Power Supply Ground

Table 5-2: Pin allocation Display 1 / Display 2

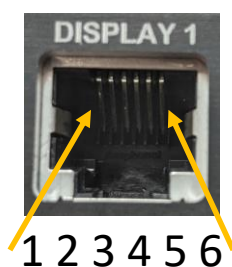

Figure 5-2: Display Connector pin allocation

5.2 GPS NMEA Connector

If an NMEA RS-232 output device is used as a GPS source, in most installations no specific action beyond simple plug-in of the RJ45 connector is required.

- The RJ45 connector has the standard IGC pinout, however only the pins Rx (**anemoi** receives data) and GND are actively used. **anemoi** does not supply or consume power nor send data (Tx) via the NMEA RJ45 connector.
- If **anemoi** is operated in parallel with other devices on the RS-232 NMEA bus, a 1:1 Y-Adapter can be used to split the signal. The P/N of the 1:1 Y-Adapter is listed in Table 3-2. As **anemoi** merely receives but does not send data on the Tx line, it is not required to detach the Tx line from **anemoi** to avoid multiple devices sending on the same line.
- Make sure that the NMEA sentence “GPRMC” (standard navigation data) is included in the output of the source device. In most cases no action is actively required to ensure sending of this sentence, as it is the most fundamental content in the NMEA protocol.
- The Baud rate of the RS-232 NMEA data stream must be one of the following: 9600, 19200, 38400, 57600, 115200 bps. If this is the case, **anemoi** will automatically adjust to the correct Baud rate.
- Maximal two receivers should be connected to a RS-232 NMEA source.

The extended pin allocation of the RJ45 GPS NMEA connector is shown in Table 5-3. A picture with the pin numbering is shown in Figure 5-3. The wiring can be made with an RJ45 cable or with an RJ12 (6P/6C) cable.

Pin Number	Signal Name	Function
1	-	do not connect
2	-	do not connect
3	-	do not connect
4	-	do not connect
5	NMEA_DATA_RX	NMEA anemoi RX Data Line
6	-	-
7	NMEA_GND	NMEA Device Power Supply Ground
8	NMEA_GND	NMEA Device Power Supply Ground

Table 5-3: Pin out GPS NMEA connector

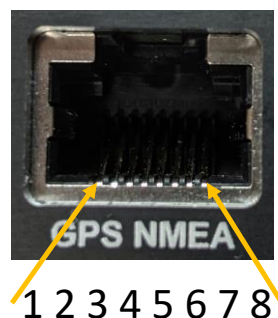

Figure 5-3: GPS NMEA Connector pin allocation

5.3 POWER Connector

The sensor unit uses a standard D-Sub 9 connector. Pin 1 is supplied with +12 VDC, Pin 5 is ground. The **anemoi** has no internal power switch. The power wire must be fused either with a 1.0 A circuit breaker or with a 1.0 A fuse in combination with a toggle switch. The P/N of a suitable circuit breaker is listed in Table 3-2. The **anemoi** is delivered with a prewired power connector harness, including two power cables and the temperature sensor.

The extended pin allocation is shown in Table 5-4. A picture with the pin numbering is shown in Figure 5-4. The numbering of the pins correlates with the D-Sub standard and not with the numbers marked on the D-Sub connector of the device.

Pin Number	Signal Name	Function
1	PWR_IN	Positive Power Supply, +12 VDC
2	DEBUG	Internal Debugging, DO NOT CONNECT
3	DEBUG	Internal Debugging, DO NOT CONNECT
4	-	do not connect
5	AC_GND	Aircraft Ground
6	DEBUG_GND	Internal Debugging GND, DO NOT CONNECT
7	TEMP_GND	Temperature Sensor Ground
8	TEMP_DATA	Temperature Sensor Data Line
9	TEMP_PWR	Temperature Sensor Positive Power Supply, +5 VDC

Table 5-4: Pin out Power Connector

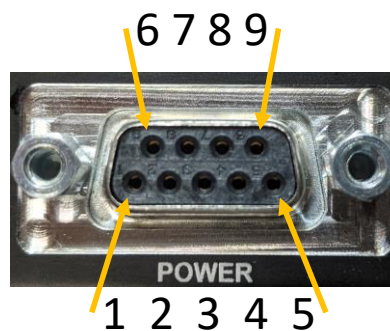

Figure 5-4: Power Connector pin allocation (D-Sub standard)

5.4 GPS Receiver Connector

The **anemoi** GPS receiver has a mating connector for the GPS port. The P/N of the receiver is listed in Table 3-2. The **anemoi** GPS receiver can be used, if no NMEA source is available in the aircraft. When the GPS receiver is connected to the **anemoi**, the GPS NMEA connector must not be used. The GPS receiver is available as an accessory and not part of the standard set.



Figure 5-5: GPS receiver

5.5 Wiring Diagram

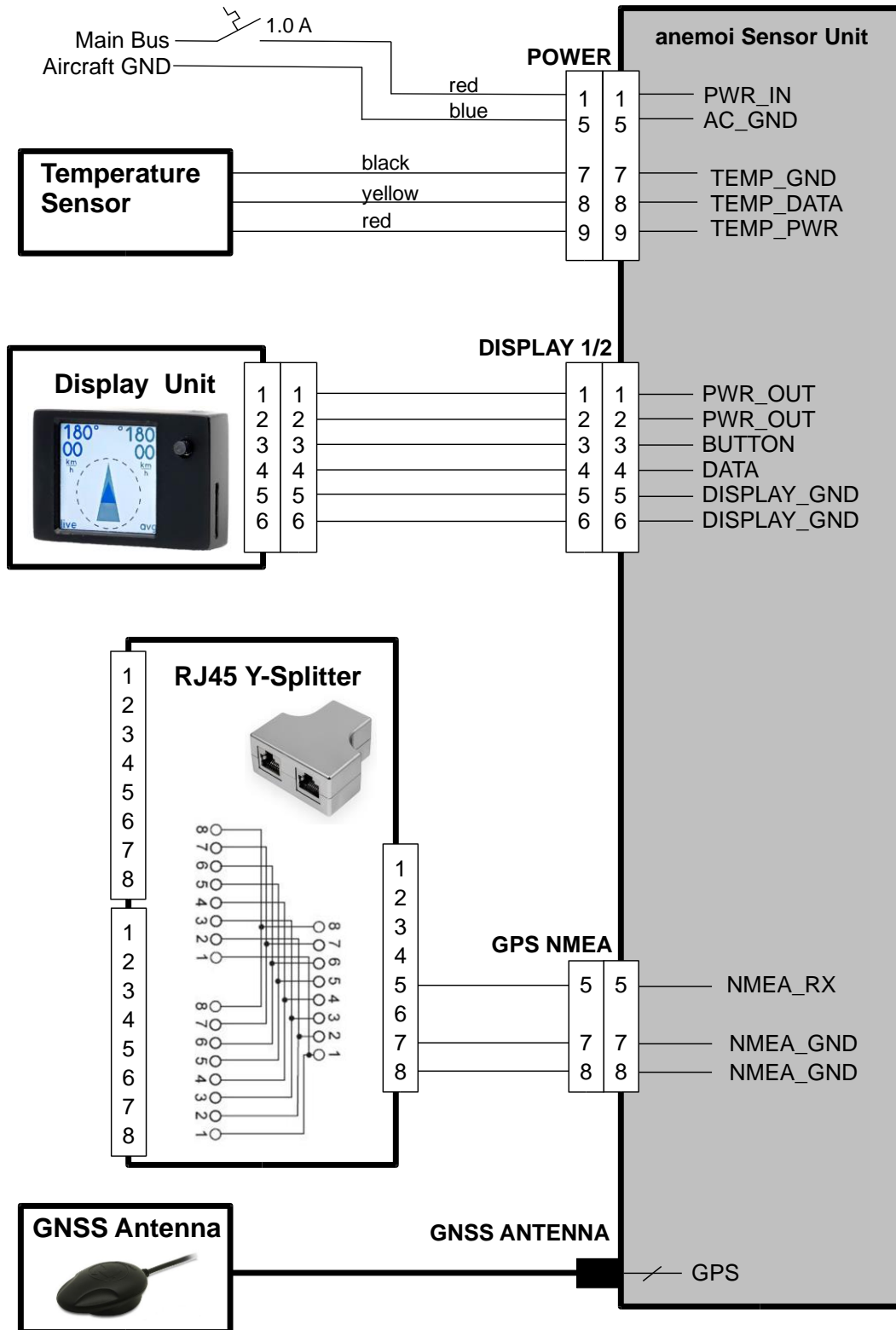

Figure 5-6: Wiring Diagram

6. Operation

In this chapter operational procedures for the **anemoi** are described.

6.1 Startup

The **anemoi** starts up as soon as the required supply voltage is provided. The subsequent startup screen is displayed for 2 seconds. The startup page is shown in Figure 6-1. The startup page gives details about the current software version while internal testing routines are performed to ensure correct operation of all electronic components and sensors (TMP, GPS, PRS, IMU). The color (green/yellow/red), see Table 6-1 for explanation, indicates the state of the respective sensor.

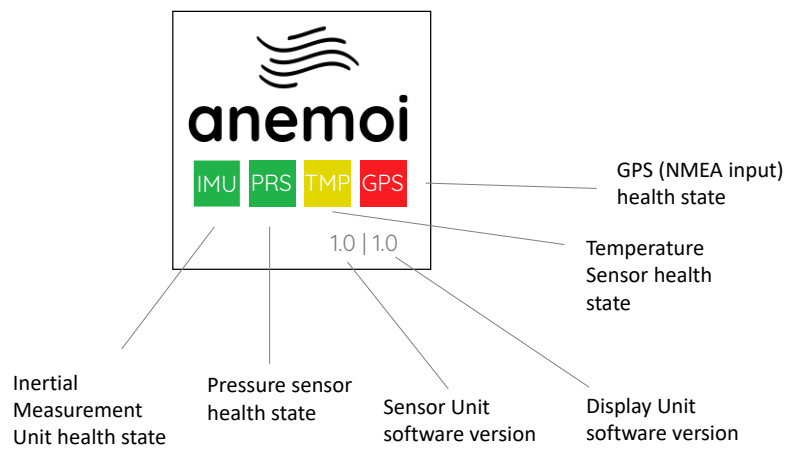

Figure 6-1: Startup screen

	IMU, PRS, TMP	GPS
Red	Not ready	No NMEA data for more than 10 s
Yellow	-	NMEA data, no GPS
Green	Ready	GPS ready

Table 6-1: Sensor health indication at system start

6.2 Display pages

Upon completion of the startup process, the display shows the operational pages. The push button (short push and release) can be used to switch between the three available pages: Wind page, AHRS page, and Data page.

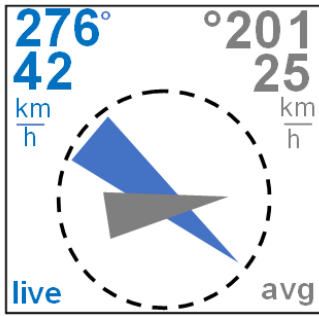

Figure 6-2: Wind page

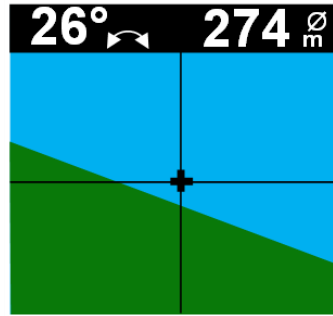

Figure 6-3: AHRS page



Figure 6-4: Data page

Wind Page

The blue arrow of the wind page symbolizes the current wind vector, and the grey arrow symbolizes the 3-minute average wind vector. The wind page is shown in Figure 6-2.

The wind vector is always shown “Heading Up”, meaning that it is aligned with the physical world outside the cockpit. The vectors point in the direction in which the wind is blowing. The wind direction indicated by the numbers is defined as the direction from which the wind is coming (aeronautical standard definition).

AHRS page

The AHRS page depicts the current bank angle of the aircraft in degrees on the left, as well as the circle diameter of the current flight path on the right. The AHRS page is shown in Figure 6-3.

Data page

The data page contains seven fields of flight data:

- True Air Speed (TAS) in km/h
- Ground Speed (GS) in km/h
- Track and Heading in degrees
- Outer Air Temperature (OAT) in degrees Celsius
- Pitot pressure calibration calculated by the Kalman Filter
- Flight Level (FL) altitude

Note: In the display software version 2.x imperial units are used instead of the metric ones.

6.3 Operation on ground

When the aircraft is on the ground, the wind page indicates a wind direction of 180° with 0 km/h. The AHRS page correctly indicates the orientation of the aircraft in pitch and roll, which can be used to check correctness of the pitch and roll mounting angles of the Sensor Unit. The Data page indicates the available data.

Heading data are not available on the ground and are indicated as “- -”.

If the incoming NMEA data provide no GPS (e. g. when the aircraft is in a hangar, or when the NMEA source has not found GPS after boot yet), GS and track are indicated as “- -”. If GPS is available on the ground, correct values for GS and track are displayed.

6.4 In-Flight operation

Based on ground speed and pitot pressure, **anemoi** switches to in-flight operation once a takeoff is detected. The system is also capable of being booted in flight and can initiate or resume normal operation immediately after boot during normal flight phases.

Use of data indicated by anemoi

Data and indications provided by **anemoi** are to be used only as an additional aid to situational awareness in flight. Safety-critical decisions must never be made based on information provided by **anemoi**. The AHRS system must never be used to intentionally fly outside of VFR conditions and is to be used exclusively as an additional aid to visual flight within legal visual flight conditions.

Data interpretation and reliability

The following examples show how **anemoi** can be used to improve situational awareness in different soaring / flying conditions:

- When approaching a ridge, **anemoi** wind indication can significantly improve the pilot's judgement of the updraft / downdraft and turbulence conditions to be expected near the terrain and help choose which ridge to fly to in search of an updraft. In mountainous terrain with ridge lift or valley wind active, low phases and outlandings can be avoided in many cases by having precise knowledge of the current wind conditions.
- When soaring in thermals, the wind in low and medium altitudes usually has a bias towards updraft cores. The difference between live and average wind can be used to infer the direction in which stronger updraft / less sink may be expected.
- During thermal circling and when flying in rotor conditions below mountain waves, the wind speed always decreases close to the center of strong updrafts, where currents from different directions are joined in one spot. This effect can be used to identify if the glider is already in the center of the updraft (indicated by a clear minimum in wind speed) or possibly not.
- When observing the average wind over longer flight durations, trends can reveal changes in the bigger picture of weather situations.

- Immediately after takeoff, and in the pattern during landing approach, a quick glimpse of the live wind vector provides valuable aid for pilots for safely planning anything from simple standard approaches to complex takeoff abort scenarios.

Due to physical constraints, the quality and reliability of the indicated wind vector has small variations depending on flight phases.

Right after takeoff: Live wind is very reliable, as the takeoff roll has given the inertial measurement platform an ideal opportunity to perfectly align.

Normal soaring maneuvering with occasional heading changes (10° or more) or airspeed changes (20 km/h or more) every 2-4 minutes: Live wind is reliable for decision taking, as the occasional slight changes in flight state can permanently keep the IMU aligned.

Circling: Live wind is almost 100% reliable. This is the best-case scenario because the IMU is continuously being kept aligned.

Mid-Flight switch-on or reboot: Live wind initially only correctly represents head / tailwind component. Once a full turn or 3-4 heading changes of 30° or more have been flown, the IMU is aligned again to correctly capture the full wind vector.

After a long, steady, unaccelerated straight flight in smooth air (20 km or more): Live wind is not fully reliable as the errors that slowly build up in the IMU cannot be fully distinguished from changes of the wind vector anymore. When in doubt, e. g. before approaching a new ridge after a very long smooth glide, it is recommended to fly 3-4 heading changes of 10° or more to allow for the IMU to re-align. Live wind will immediately update to indicate the correct wind vector. Note that such small maneuvers are usually unconsciously done on a regular basis (every few minutes, which is fully sufficient) by soaring pilots trying to find the best energy line, even during long glides.

6.5 Setup Menu

Holding the push button for 2 seconds on any of the three main pages opens the setup menu, seen in Figure 6-5. By pressing the push button, one can navigate through the menu, holding the push button starts the respective operations.

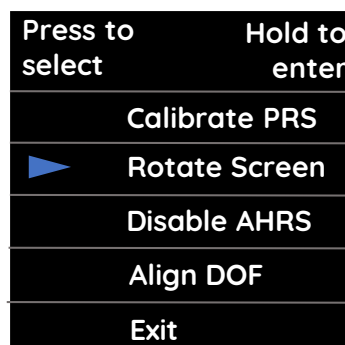

Figure 6-5: Setup menu

Calibrate PRS

The **anemoi** pitot pressure sensor must be calibrated at least once after installation of the device. Calibration must be done indoors (e. g. hangar). To compensate for any long-term drift of the differential pressure sensor, a new calibration should be done if the TAS indication exceeds 20 km/h on ground in calm wind.

Note that at low airspeed (i. e. on the ground), very small measurement deviations can already cause significant TAS values, while at flying airspeeds, such errors are diminished. Additionally, airspeed measurement errors are calibrated in flight by the **anemoi** algorithm. Therefore, indications of < 20 km/h on the ground in calm wind can be ignored. The Calibrate Pressure page is shown in Figure 6-6.

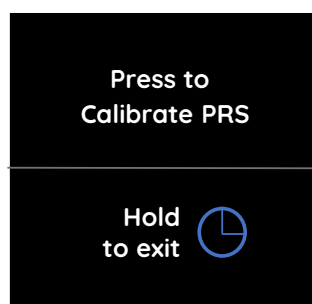

Figure 6-6: Calibrate Pressure page

Rotate Screen

The screen of the display unit can be rotated in 90 ° steps.

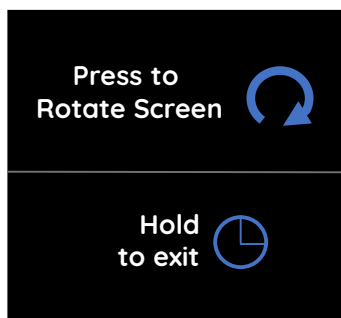

Figure 6-7: Rotate Screen page

Disable AHRS

AHRS indication can be manually disabled (e. g. for competitions). The duration for which the AHRS will be unavailable can be selected in days, with a maximum of 30 consecutive days. If a duration of 0 days is selected, the system will not be locked. A duration of 1 day means that the system will be

locked for the rest of the present day, and will unlock when booted on the next day, or after (and so on).

After choosing a duration (Figure 6-8) and confirming (Figure 6-9), AHRS will be locked for the chosen amount of time. Note that GPS signal is required to lock the AHRS, as time and date information is transferred via NMEA. If no GPS signal is available, the system will not be locked, and an error message will be displayed.

After the system has been locked, instead of the AHRS main page (Figure 6-3), a locked page (Figure 6-10) will now be displayed. The date indicated on top of the page is the first day on which the AHRS will be available again.

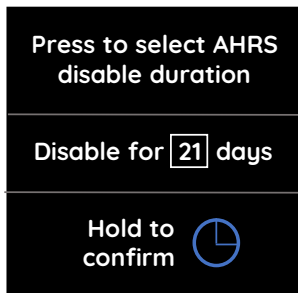

Figure 6-8: Disable AHRS page 1

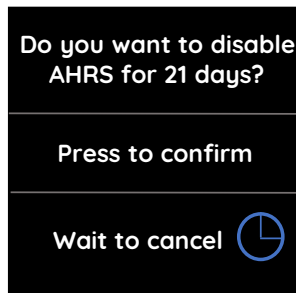

Figure 6-9: Disable AHRS page 2

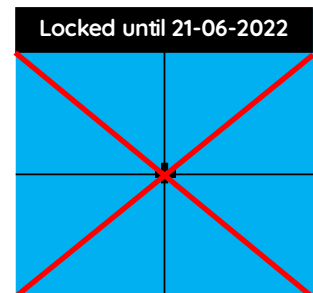

Figure 6-10: AHRS locked page

Align DOF

By default, direction A points in the DOF. If the sensor unit is installed in any of the three other directions (e. g. B/C/D) this needs to be set in the menu.

To set the direction of flight in which the sensor unit is mounted, open the “Align DOF” option and select the correct orientation, then hold the button to confirm. The Align DOF page is shown in Figure 6-11.

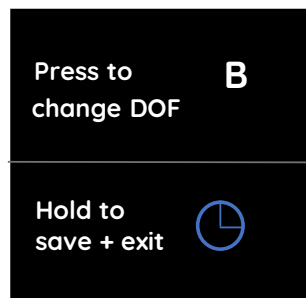

Figure 6-11: Align DOF page

Exit

Holding the push button, exits the setup operation menu and restarts the **anemoi** with the startup screen, as can be seen in Figure 6-1. After that the wind page shows up.

6.6 Errors

Sensor error

As soon as an error in any of the four sensors (GPS, IMU, PRS, TMP) appears, **anemoi** switches to the startup screen. The malfunctioning sensor is highlighted with a red color. In Figure 6-12 there is an exemplary GPS error displayed which occurred due to a lack of satellite signal reception. In Table 6-2 the different states due to a reboot after an error are listed. 10 s without valid GPS data is considered as a sensor fault. If the **anemoi** frequently switches to the reboot screen in combination with a red GPS field, this is an indication for a poor GPS receiving. The mounting position of the GPS receiver antenna should be checked.

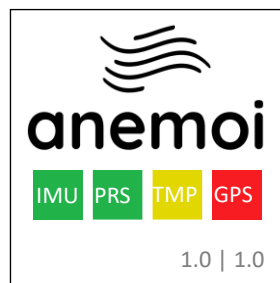

Figure 6-12: Startup screen with GPS error

	IMU, PRS, TMP	GPS
Red	Sensor fault, re-initializing	NMEA/GPS loss > 5 s
Yellow	Sensor healthy, re-initializing	NMEA data healthy
Green	Sensor ready again	GPS data healthy

Table 6-2: Sensor health indication at system reboot due to sensor fault

-no data-

This will be displayed if there is no communication between sensor and display unit. There is a failure on either of the two ends. Reboot should solve the problem unless there is a defect on either of the units. Also make sure that both units are properly connected.

6.7 Firmware / Software Update

The **anemoi** allows for easy conduction of software updates through the microSD interface. The software is delivered in compressed .zip-files with the following exemplary structure:

```
fw_anemoi_sensor_v1.0.zip -> sensor.bin  
fw_anemoi_display_v1.0.zip -> display.bin
```

The binary software upgrade files (.bin) have to be copied on a microSD. The microSD card has to be placed inside the microSD card slot. To update the sensor unit, the microSD card with the *sensor.bin* file has to be placed inside the sensor unit. To update the display unit, the microSD card with the *display.bin* file has to be placed inside the display unit.

The binary file is recognized by the **anemoi** when power is applied, and the device boots up. When an update file is detected, the content is automatically programmed into flash memory and the device starts up using the new software. Upon successful firmware update, the binary file is deleted from the microSD. If you need to do another firmware update, you have to follow the same procedure as above.

Please ensure every step before flashing.

- Use a microSD card with max. 32 GB
- Make sure to format the microSD card in FAT32 format (exFAT/NTFS is not supported!)
- Ensure the microSD card is empty
- Download the latest firmware from the **anemoi** website (<https://www.fly-anemoi.com/pages/downloads>)
- Do not rename the firmware file

Flashing mechanism sensor unit:

- Power off the **anemoi** sensor unit
- Copy the downloaded binary file: *sensor.bin* in the root directory of the microSD card
- Insert the microSD card in the sensor unit
- Power on the **anemoi** sensor unit

Flashing mechanism display unit:

- Power off the **anemoi** sensor unit
- Copy the downloaded binary file: *display.bin* in the root directory of the microSD card
- Insert the microSD card in the display unit
- Power on the **anemoi** sensor unit

The new firmware version is displayed on the startup screen.

7. Abbreviations and Terms

Abbreviation	Description
ACT	Active
ACV	Aircraft Voltage
AHRS	Attitude Heading Reference System
DOF	Direction of Flight
FL	Flight Level
GNSS / GPS	Global Navigation Satellite System (e. g. GPS, Galileo, GLONASS)
GS	Ground Speed
hdg	Heading
IMU	Inertial Measurement Unit
LCD	Liquid Crystal Display
NMEA	National Marine Electronics Association
PRS	Pressure
OAT	Outer Air Temperature
RJ	Registered Jack
RS-232	Recommended Standard 232
RX	Reception
SBY	Standby
SD	Secure Digital (type of memory card)
SDHC	Secure Digital – High Capacity (type of SD card)
TAS	True Air Speed
TMP	Temperature
TX	Transmission
UTC	Coordinated Universal Time



RS Flight Systems GmbH

Oberer Luessbach 29-31

82335 Berg | Germany

anemoi@rs-flightsystems.com

www.rs-flightsystems.com

anemoi | Version: 1.06

© Copyright 2023 RS Flight Systems GmbH